

**ERSATZTEILLISTE • SPARE PARTS LIST • LISTE DE PIÈCES DE RECHANGE
LISTINO PEZZI DI RICAMBIO • LISTA DE PIEZAS DE RECAMBIO**

Ø 6.8

**DREHSCHIEBERPUMPEN • ROTARY VANE PUMPS • POMPES À PALETTES
POMPE A PALETTE • BOMBAS DE PALETAS**

MAKE IT BECKER.

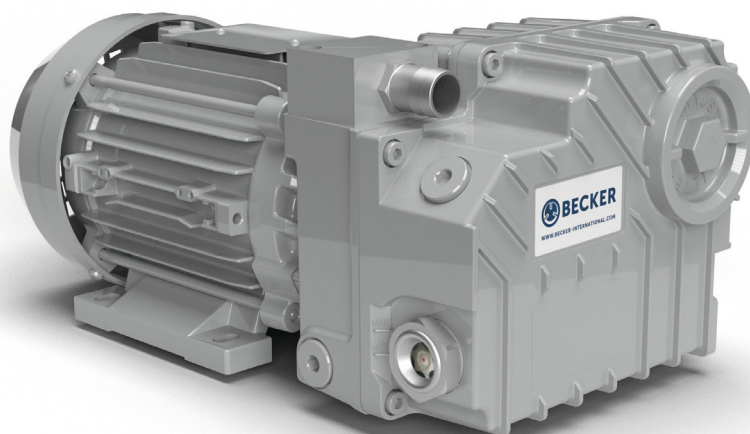

INDEX

INDEX/INDICE

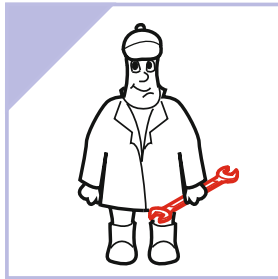

BECKER

year XX/20XX
No. **A1234567**

Compressor / vacuum

type	XXX
frequency	XXX
speed	XXX
power required	XXX
inlet capacity	XXX
pressure	XXX
vacuum	XXX

z
min⁻¹
kW
m³/h
mbar
mbar

Geb. Becker GmbH
Höcker Feld 29
WUPPERTAL
GERMANY
www.becker-international.com
Made in germany

INDEX



WWW.BECKER-INTERNATIONAL-SHOP.COM

wichtige Komponenten - Serviceteile
important components - Service Parts
composants importants - Pièces de service
importanti componenti - Parti di servizio
componentes importantes - Partes de servicio

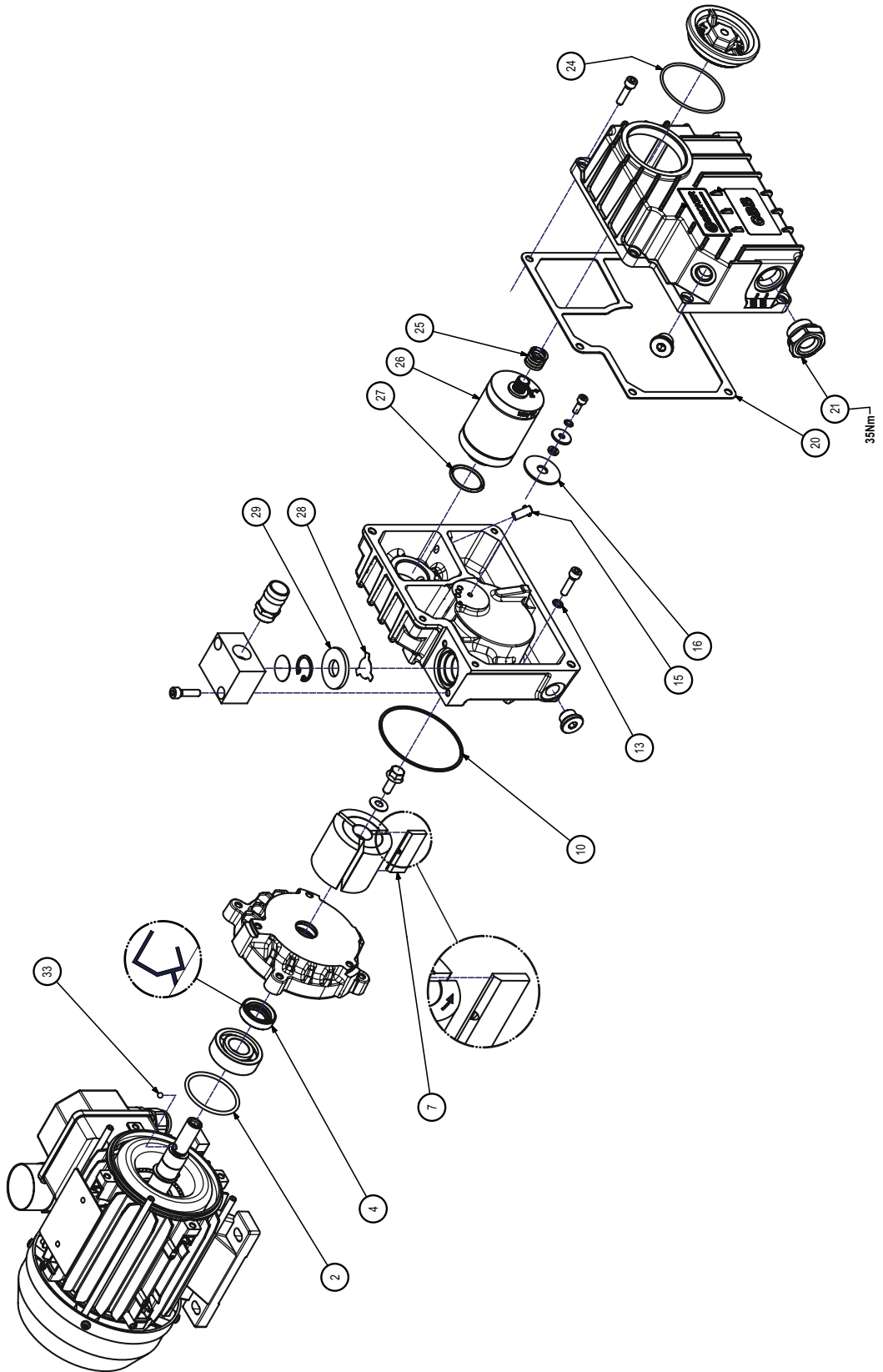

INDEX	Pos.	Ident No.	Description	Quantity
	K1	969900 14000	BASIC MAINTENANCE KIT	KIT
	K2	969900 15000	EXTENDED MAINTENANCE KIT	KIT
		960017 00025	BECKER LUBE M 32 (MINERAL OIL)	0,25 l
		960003 20025	BECKER LUBE S 32 (SYNTHETIC OIL)	0,25 l
		960023 00901	BECKER LUBE SL 32 (FOOD SECTOR)	1 l
		960037 00501	BECKER LUBE SM 32 (FOOD SECTOR)	1 l



INDEX	Pos.	Bestell Nr.	Beschreibung	
	2	K2	O-RING	
	4	K2	WELLENDICHTRING	
	7	K2	SCHIEBERSATZ	
	10	K2	O-RING	
	13	K2	UNTERLEGSCHIEBE	
	15	K2	ÖLRÜCKLAUFVENTIL	
	16	K2	GUMMIVERSCHLUSS	
	20	K2	DICHTUNG	
	21	K2	ÖLSCHAUGLAS	
	24	K1, K2	O-RING	
	25	K2	FEDER	
	26	K1, K2	LUFTENTÖLELEMENT	
	27	K1, K2	O-RING	
	28	K2	SICHERUNGSRING	
	29	K2	SCHEIBE	
	33	K2	PASSFEDER	
		960017 00025	ÖLGEBINDE 0,25 LITER (BECKER LUBE M 32)	
		960003 20025	ÖLGEBINDE 0,25 LITER (BECKER LUBE S 32)	
		960023 00901	ÖLGEBINDE 1 LITER (BECKER LUBE SL 32)	
		960037 00501	ÖLGEBINDE 1 LITER (BECKER LUBE SM 32)	

K1 / BASIS-WARTUNGSSATZ - 969900 14000 → POS.: 24, 26, 27

K2 / ERWEITETER WARTUNGSSATZ - 969900 15000 → POS.: 2, 4, 7, 10, 13, 15, 16, 20, 21, 24, 25, 26, 27, 28, 29, 33

INDEX	Pos.	Ident No.	Description	
	2	K2	O-RING	
	4	K2	SHAFT SEAL RING	
	7	K2	ROTOR VANE KIT	
	10	K2	O-RING	
	13	K2	WASHER	
	15	K2	OIL RECOVERY VALVE	
	16	K2	RUBBER SEAL	
	20	K2	GASKET	
	21	K2	OIL SIGHT GLASS	
	24	K1, K2	O-RING	
	25	K2	SPRING	
	26	K1, K2	OIL SEPARATING ELEMENT	
	27	K1, K2	O-RING	
	28	K2	LOCKING PLATE	
	29	K2	DISC	
	33	K2	KEY	
		960017 00025	OIL CANISTER 0,25 LITER (BECKER LUBE M 32)	
		960003 20025	OIL CANISTER 0,25 LITER (BECKER LUBE S 32)	
		960023 00901	OIL CANISTER 1 LITER (BECKER LUBE SL 32)	
		960037 00501	OIL CANISTER 1 LITER (BECKER LUBE SM 32)	

K1 / BASIC MAINTENANCE KIT - 969900 14000 → POS.: 24, 26, 27

K2 / EXTENDED MAINTENANCE KIT - 969900 15000 → POS.: 2, 4, 7, 10, 13, 15, 16, 20, 21, 24, 25, 26, 27, 28, 29, 33

INDEX	Pos.	No. d'identification	Designation
	2	K2	JOINT TORIQUE
	4	K2	BAGUE D'ÉTANCHÉITÉ D'ARBRE
	7	K2	KIT DE PALETTES
	10	K2	JOINT TORIQUE
	13	K2	RONDELLE
	15	K2	SOUPAPE DE RÉCUPÉRATION D'HUILE
	16	K2	JOINT EN CAOUTCHOUC
	20	K2	JOINT
	21	K2	VOYANT D'HUILE
	24	K1, K2	JOINT TORIQUE
	25	K2	RESSORT
	26	K1, K2	ÉLÉMENT SÉPARATEUR D'HUILE
	27	K1, K2	JOINT TORIQUE
	28	K2	PLAQUE DE VERROUILLAGE
	29	K2	RONDELLE
	33	K2	CLAVETTE
		 960017 00025	CONTENEUR D'HUILE 0,25 LITRE (BECKER LUBE M 32)
		960003 20025	CONTENEUR D'HUILE 0,25 LITRE (BECKER LUBE S 32)
		960023 00901	CONTENEUR D'HUILE 1 LITRE (BECKER LUBE SL 32)
		960037 00501	CONTENEUR D'HUILE 1 LITRE (BECKER LUBE SM 32)

K1 / KIT DE MAINTENANCE DE BASE - 969900 14000 ➔ POS.: 24, 26, 27

K2 / KIT DE MAINTENANCE ÉTENDU - 969900 15000 ➔ POS.: 2, 4, 7, 10, 13, 15, 16, 20, 21, 24, 25, 26, 27, 28, 29, 33

INDEX	Pos.	No. identificazione	Designazione
	2	K2	O-RING
	4	K2	GUARNIZIONE DELL'ALBERO
	7	K2	KIT DI PALETTE
	10	K2	O-RING
	13	K2	RONDELLA
	15	K2	VALVOLA RECUPERO OLIO
	16	K2	OTTURATORE IN GOMMA
	20	K2	GUARNIZIONE
	21	K2	SPIA DI LIVELLO OLIO
	24	K1, K2	O-RING
	25	K2	MOLLA
	26	K1, K2	CARTUCCIA SEPARATORE OLIO
	27	K1, K2	O-RING
	28	K2	OTTURATORE LAMELLARE
	29	K2	RONDELLA
	33	K2	CHIAVETTA
		 960017 00025	CONTENITORE DELL'OLIO 0,25 LITRO (BECKER LUBE M 32)
		960003 20025	CONTENITORE DELL'OLIO 0,25 LITRO (BECKER LUBE S 32)
		960023 00901	CONTENITORE DELL'OLIO 1 LITRO (BECKER LUBE SL 32)
		960037 00501	CONTENITORE DELL'OLIO 1 LITRO (BECKER LUBE SM 32)

K1 / KIT DI MANUTENZIONE DI BASE - 969900 14000 ➔ POS.: 24, 26, 27

K2 / KIT DI MANUTENZIONE ESTESE - 969900 15000 ➔ POS.: 2, 4, 7, 10, 13, 15, 16, 20, 21, 24, 25, 26, 27, 28, 29, 33

INDEX	Pos.	No. de pedido	Descripción	
	2	K2	JUNTA TÓRICA	
	4	K2	ANILLO DE SELLO DEL EJE	
	7	K2	KIT DE PALETA DE ROTOR	
	10	K2	JUNTA TÓRICA	
	13	K2	ARANDELA	
	15	K2	VÁLVULA DE RECUPERACIÓN DE ACEITE	
	16	K2	JUNTA DE GOMA	
	20	K2	JUNTA	
	21	K2	CRISTAL MIRILLA DE ACEITE	
	24	K1, K2	JUNTA TÓRICA	
	25	K2	PRIMAVERA	
	26	K1, K2	ELEMENTO SEPARADOR DE ACEITE	
	27	K1, K2	JUNTA TÓRICA	
	28	K2	PLACA DE BLOQUEO	
	29	K2	ARANDELA	
	33	K2	CHAVETA	
		960017 00025	CONTENEDOR DE ACEITE 0,25 LITRO (BECKER LUBE M 32)	
		960003 20025	CONTENEDOR DE ACEITE 0,25 LITRO (BECKER LUBE S 32)	
		960023 00901	CONTENEDOR DE ACEITE 1 LITRO (BECKER LUBE SL 32)	
		960037 00501	CONTENEDOR DE ACEITE 1 LITRO (BECKER LUBE SM 32)	

K1 / KIT DE MANTENIMIENTO BÁSICAS - 969900 14000 → POS.: 24, 26, 27

K2 / KIT DE MANTENIMIENTO AMPLIADO - 969900 15000 → POS.: 2, 4, 7, 10, 13, 15, 16, 20, 21, 24, 25, 26, 27, 28, 29, 33



MAKE IT BECKER.

28000055500 | 2022-04-27 | All rights reserved